

Article number: 20476727

Description: E+G Tommy screw with movable bar
DIN 6306M 20-70-E

Measures

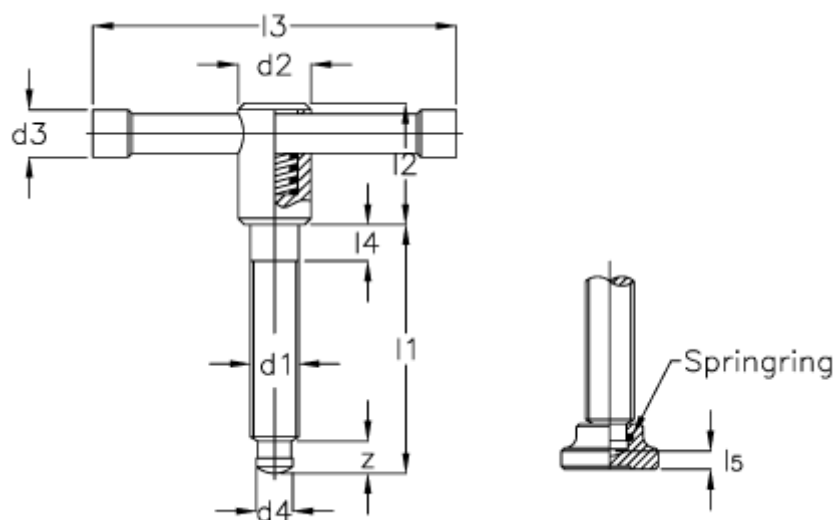

d1	= M 20	l5 = 5.6
d2	= 30	z = 12.4
d3	= 16	
d4	h11 = 15.5	
l1	= 70	
l2	= 45	
l3	= 140	
l4	= 10	